

Montagematerial
Installation materials

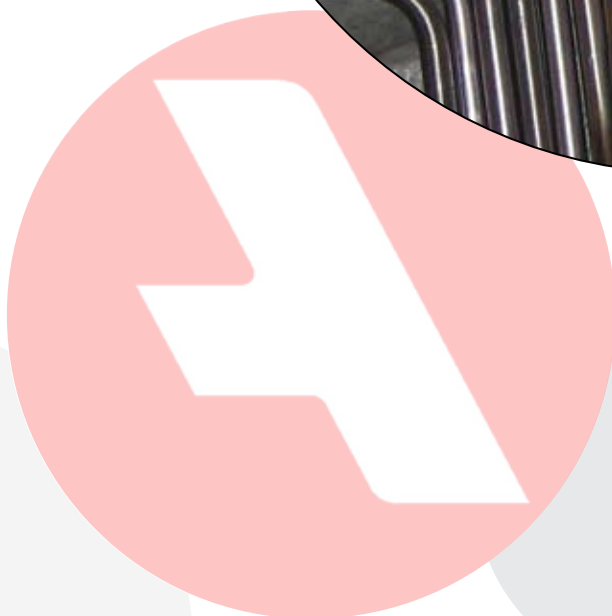

Montagematerial

Assalub har egna montörer med stor erfarenhet, vilket garanterar ett professionellt utfört arbete.

Assalub has their own staff of installation engineers, which guarantees that all installation work is done professionally.

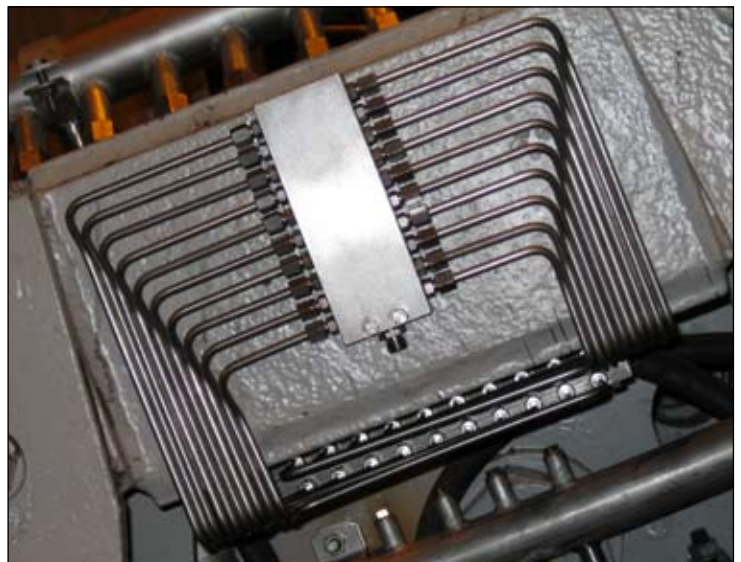
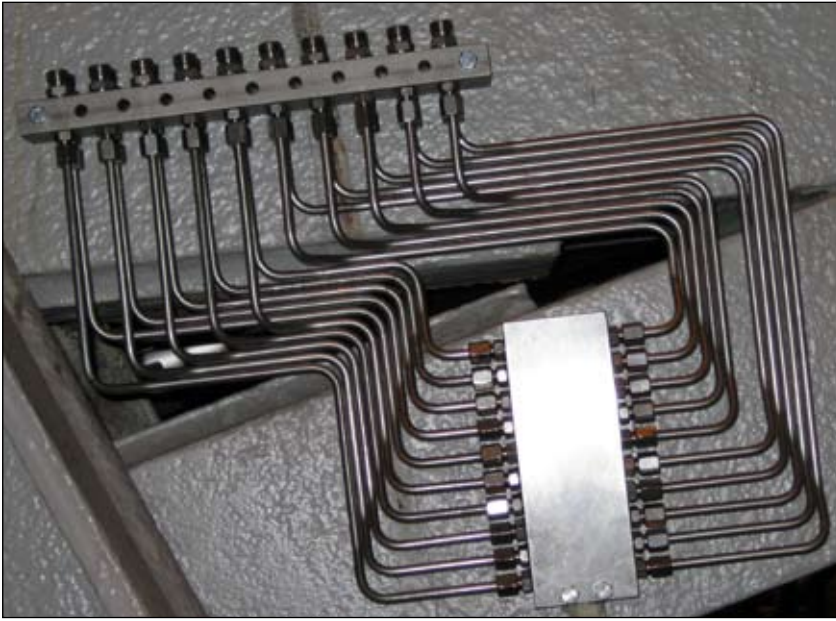

Rörsatser, kompletta för 1 m rör

Finns för fem olika rördimensioner. Nedanstående tabell visar vad som ingår i varje komplett artikelnummer.

12x1 FZ	Art.nr: 0102333
22x2 FZ	Art.nr: 0102334
28x2,5 FZ	Art.nr: 0102335
30x4 FZ	Art.nr: 0102336
22x2 SS	Art.nr: 0102337

Tube kits, complete for 1 m tube

Available for five different tube dimensions. The table below shows what each complete tube kit number comprises.

12x1 FZ	Art.No: 0102333
22x2 FZ	Art.No: 0102334
28x2,5 FZ	Art.No: 0102335
30x4 FZ	Art.No: 0102336
22x2 SS	Art.No: 0102337

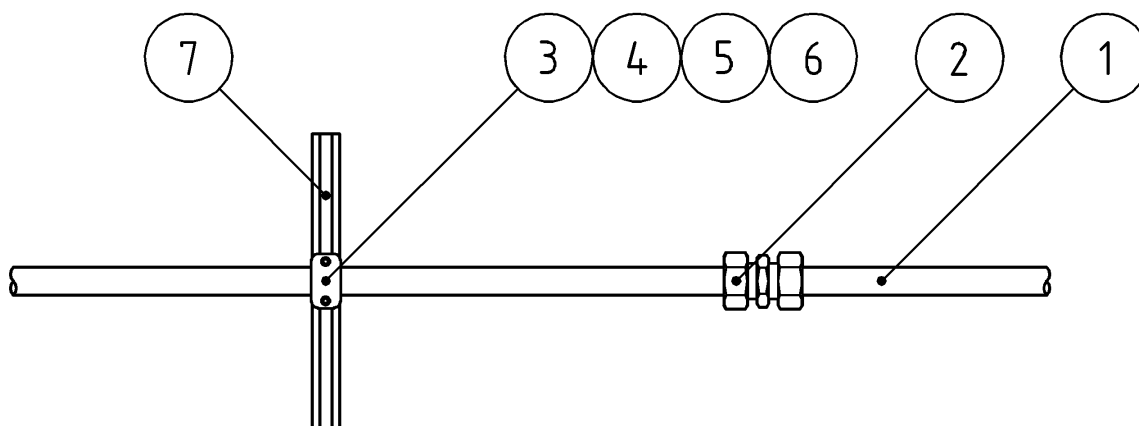

Pos.	Artikel	Article	Art.nr: Art.No:	Antal (st/m) för varje komplett rörsats med art.nr: Qty. (pcs/m) for each complete tubekit with art.no:				
				0102333	0102334	0102335	0102336	0102337
1	Rör 12x1 FZ	Tube 12x1 Zn	900172	1	-	-	-	-
1	Rör 22x2 FZ	Tube 22x2 Zn	3102007	-	1	-	-	-
1	Rör 28x2.5 FZ	Tube 28x2.5 Zn	3102009	-	-	1	-	-
1	Rör 30x4 FZ	Tube 30x4 Zn	903022	-	-	-	1	-
1	Rör 22x2 SS	Tube 22x2 SS	3104003	-	-	-	-	1
2	G12 L FZ	G12 L Zn	903992	0.2	-	-	-	-
2	G22 L FZ	G22 L Zn	3201037	-	0.2	-	-	0.2
2	G28 L FZ	G28 L Zn	3201039	-	-	0.2	-	-
2	G30 S FZ	G30 S Zn	3201156	-	-	-	0.2	-
3	Rörhållare 12	Tube holder 12	3413001	0.5	-	-	-	-
3	Rörhållare 22	Tube holder 22	3413002	-	0.5	-	-	0.5
3	Rörhållare 28	Tube holder 28	3413004	-	-	0.5	-	-
3	Rörhållare 30	Tube holder 30	3413032	-	-	-	0.5	-
4	Skruv 6x20 FZ	Screw 6x20 Zn	903370	0.5	-	-	-	-
4	Skruv 6x30 FZ	Screw 6x30 Zn	3402021	-	1	-	-	-
4	Skruv 6x35 FZ	Screw 6x35 Zn	3402023	-	-	1	1	-
4	Skruv 6x30 SS	Screw 6x30 SS	3404030	-	-	-	-	1
5	O-ring	O-ring	902767	0.5	1	1	1	1
6	T-mutter	T-nut	902766	0.5	1	1	1	1
7	C-skena	C-rail	902765	0.04	0.05	0.05	0.05	0.05

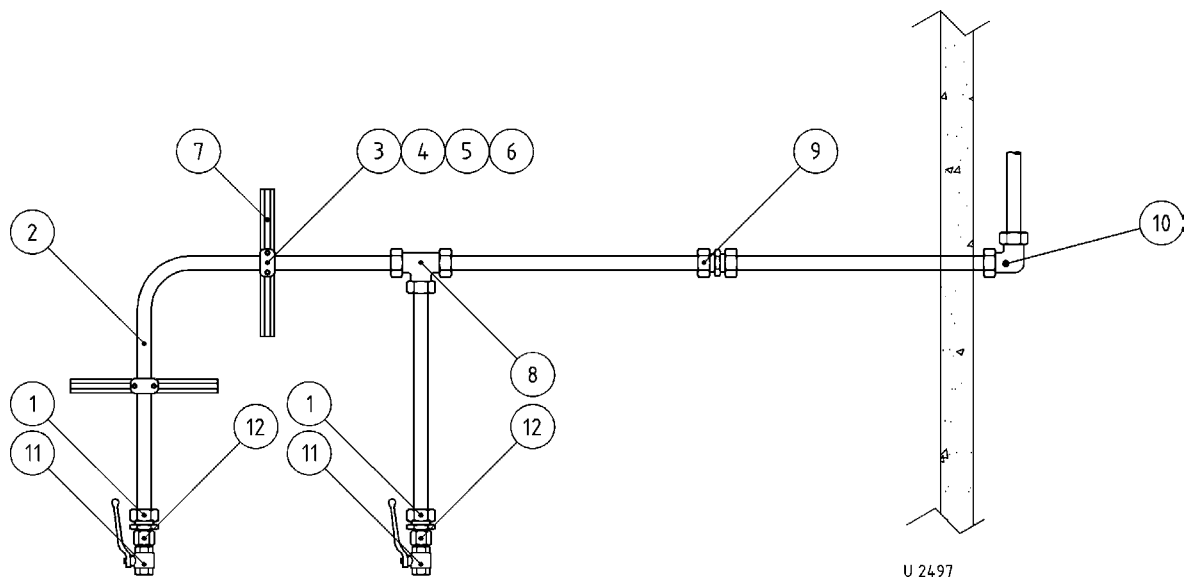

Installationsdetaljer för luftledningar Rör 12x1 mm <i>Installation materials for air-lines</i> Tube 12x1 m			
Pos.	Beskrivning	Description	Art.nr. / Art.No:
1	GE 12 L ISO-G1/4 FZ	GE 12 L ISO-G1/4 Zn	3201019
	GE 12 L ISO-G1/2 FZ	GE 12 L ISO-G1/2 Zn	903999
2	Rör 12x1 Rostfritt SS2333	Tube 12x1 Stainless AISI 304	3104002
3	Rörhållare 112	Tube clamp 112	3413001
4	Skruv MCS 6x20	Screw MCS 6x20	903370
5	T-mutter	T-nut	902766
6	O-ring	O-ring	902767
7	L-skena	Support rail	902765
8	T 12 L FZ	T 12 L Zn	3201004
9	G 12 L FZ	G 12 L Zn	903992
10	W 12 L FZ	W 12 L Zn	904058
11	Kulventil 1/4"	Ball valve 1/4"	0904936

Installationsdetaljer för oljeledningar Rör 22x2 mm. För rörlängd 0-50 meter. <i>Installation materials for oil-lines</i> Tube 22x2 mm. For tubing lengths 0-50 meters.			
Pos.	Beskrivning	Description	Art.nr. / Art.No:
1	GE 22 L ISO-G1/2 FZ	GE 22 L ISO-G1/2 Zn	3201172
	GE 22 L ISO-G3/4 FZ	GE 22 L ISO-G3/4 Zn	3201115
2	Rör 22x2 FZ	Tube 22x2 Zn	3102007
3	Rörhållare 322	Tube clamp 322	3413002
4	Skruv MCS 6x30	Screw MCS 6x30	3402021
5	T-mutter	T-nut	902766
6	O-ring	O-ring	902767
7	L-skena	Support rail	902765
8	T 22 L FZ	T 22 L Zn	3201005
9	G 22 L FZ	G 22 L Zn	3201037
10	W 22 L FZ	W 22 L Zn	3201209
11	Kulventil 1/2"	Ball valve 1/2"	0230244
11	Kulventil 3/4"	Ball valve 3/4"	0230245

Installationsdetaljer för oljeledningar Rör 28x2 mm. För rörlängd 50-100 meter.
Installation materials for oil-lines Tube 28x2 mm. For tubing lengths 50-100 meters.

Pos.	Beskrivning	Description	Art.nr. / Art.No:
1	GE 28 L ISO-G3/4 FZ	GE 28 L ISO-G3/4 Zn	3201159
	GE 28 L ISO-G1 FZ	GE 28 L ISO-G1 Zn	3201134
2	Rör 28x2 FZ	Tube 28x2 Zn	906979
3	Rörhållare 428	Tube clamp 428	3413004
4	Skruv MCS 6x35	Screw MCS 6x35	3402023
5	T-mutter	T-nut	902766
6	O-ring	O-ring	902767
7	L-skena	Support rail	902765
8	T 28 L FZ	T 28 L Zn	3201008
9	G 28 L FZ	G 28 L Zn	3201039
10	W 28 L FZ	W 28 L Zn	3201220
11	Kulventil 1/2"	Ball valve 1/2"	0230244
11	Kulventil 3/4"	Ball valve 3/4"	0230245

Installationsdetaljer för fettledningar Rör 30x4 mm. För rörlängd 0-40 meter.
Installation materials for grease lines Tube 30x4 mm. For tubing lengths 0-40 meters.

Pos.	Beskrivning	Description	Art.nr. / Art.No:
1	GE 30 S ISO-G3/4 FZ	GE 30 S ISO-G3/4 Zn	903056
2	Rör 30x4 FZ	Tube 30x4 Zn	903022
3	Rörhållare 430	Tube clamp 430	3413032
4	Skruv MCS 6x40	Screw MCS 6x40	906172
5	T-mutter	T-nut	902766
6	O-ring	O-ring	902767
7	L-skena	Support rail	902765
8	T 30 S FZ	T 30 S Zn	3201009
9	G 30 S FZ	G 30 S Zn	3201156
10	W 30 S FZ	W 30 S Zn	906431
11	Kulventil 1/2"	Ball valve 1/2"	0904901
	Kulventil 1/4"	Ball valve 1/4"	0230245
12	RI 1/2" - 3/4" FZ	RI 1/2" - 3/4" FZ	906220

Installationsdetaljer för aggressiva vätskor Rör 22x2 mm. För rörlängd 0-250 meter.
Installation materials for aggressive fluids Tube 22x2 mm. For tubing lengths 0-250 meters

Pos.	Beskrivning	Description	Art.nr. / Art.No:
1	GE 22 L ISO-G1/2 SF	GE 22 L ISO-G1/2 acid-proof	906430
2	Rör 22x2 rostfritt SS2333	Tube 22x2 stainless AISI 304	3102007
3	Rörhållare 322	Tube clamp 322	3413032
4	Skruv MCS 6x30 SS2343	Screw MCS 6x30 AISI 316	3404030
5	T-mutter	T-nut	902766
6	O-ring	O-ring	902767
7	L-skena	Support rail	902765
8	T 22 L SF, SS2343	T 22 L acid-proof, AISI 316	3204005
9	G 22 L SF, SS2343	G 22 L acid-proof, AISI 316	3204037
10	W 22 L SF, SS2343	W 22 L acid-proof, AISI 316	906429
11	Kulventil 1/2"	Ball valve 1/2"	0230244
	Kulventil 3/4"	Ball valve 3/4"	0230245



Montagematerial

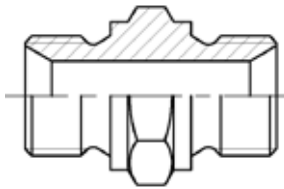

Adapter, Utv. ISO-G - Utv. ISO-G Adapter, male ISO-G - male ISO-G	Art.nr. Art.No:
1/4" - 1/4"	904757
1/4" - 1/2"	906427
1/4" - 3/4"	906547
3/8" - 3/8"	906715
3/8" - 1/2"	0018918
3/8" - 5/8"	SKÖ1950/III
1/2" - 1/2"	904104
1/2" - 3/4"	0018919
3/4" - 1"	0230280
1" - 1"	0904974
1/4" - 1/4" Syrafast SS2343 / Acid-proof AISI 316	902958
3/8" - 1/2" Syrafast SS2343 / Acid-proof AISI 316	902992
1/2" - 1/2" Syrafast SS2343 / Acid-proof AISI 316	902993

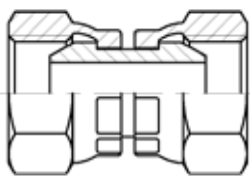

Adapter, Inv. rörlig ISO-G - Inv. rörlig ISO-G Adapter, female turnable ISO-G - female turnable ISO-G	Art.nr. Art.No:
1/4" - 1/4"	902902
1/4" - 1/4" Syrafast SS2343 / Acid-proof AISI 316	902960
3/8" - 3/8" Syrafast SS2343 / Acid-proof AISI 316	902991

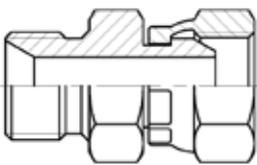

Adapter, Utv. ISO-G - Inv. rörlig ISO-G Adapter, male ISO-G - female turnable ISO-G	Art.nr. Art.No:
1/4" - 1/4"	902498
3/8" - 1/2"	904122
1/2" - 1/2"	904099

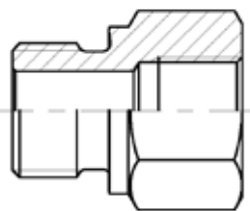

Adapter, Utv. ISO-G - Inv. ISO-G Adapter, male ISO-G - female ISO-G	Art.nr. Art.No:
1/8" - 1/4"	3201088
1/4" - 1/8"	904103
3/8" - 1/4"	3201120
3/8" - 1/2"	904094
1/2" - 1/4" Kort / short	3201200
1/2" - 3/4"	906220
3/4" - 1/2"	3201092
3/4" - 1"	3201198
1" - 3/4"	3201199

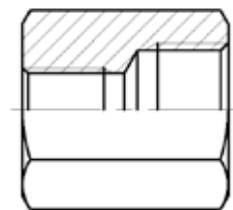

Muff, Inv. ISO-G - Inv. ISO-G Sleeve, female ISO-G - female ISO-G	Art.nr. Art.No:
1/8" - 1/8"	1117085
1/4" - 1/4"	906441
1/2" - 1/2"	906443



Adapter, Utv. ISO-G - Utv. ISO-R (konisk) Adapter, male ISO-G - male ISO-R (tapered)	Art.nr. Art.No:
1/4" - 1/8"	904128
1/4" - 1/4"	904139
1/4" - 1/2"	906640
3/8" - 1/2"	906078
1/2" - 1/2"	906545
3/4" - 3/4"	0230263
1/2" - 3/8"	904100
3/8" - 3/8" Syrafast SS2343 / Acid-proof AISI 316	902990

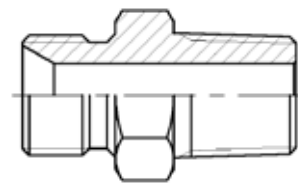

Adapter, Inv. rörlig ISO-G - Utv. NPT Adapter, female turnable ISO-G - male NPT	Art.nr. Art.No:
3/8" - 3/8"	906079

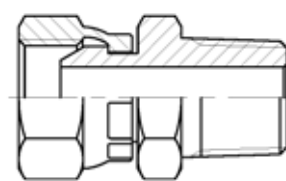

Vinkeladapter 90°, Utv. ISO-G - Inv. vridbar ISO-G Elbow adapter 90o, male ISO-G - female turnable ISO-G	Art.nr. Art.No:
1/4" - 1/4"	902483
1/2" - 1/2"	906714
3/4" - 3/4"	904101

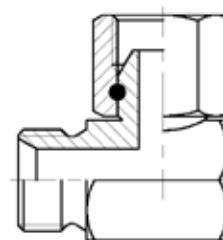

T-adapter, Inv. ISO-G - Inv. ISO-G - Inv. ISO-G T-adapter, female ISO-G - female ISO-G - female ISO-G	Art.nr. Art.No:
1/8" - 1/8" - 1/8"	906580

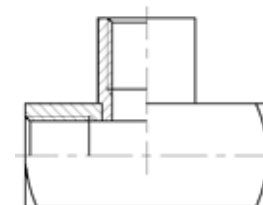

T-adapter, Utv. ISO-G - Utv. ISO-R - Utv. ISO-G T-adapter, male ISO-G - male ISO-R - male ISO-G	Art.nr. Art.No:
1/4" - 1/4"	902901

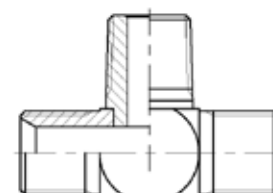

Insexplugg, Utv. ISO-G Allen wrench plug, male ISO-G	Art.nr. Art.No:
1/4" FZ / Zn	906582
1/4" SF / SS	906581

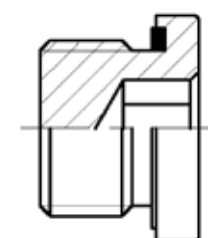

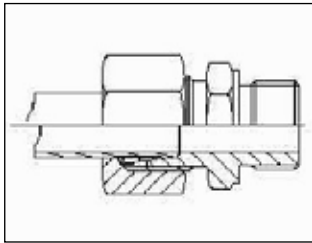

Skärningskopplingar

Cut ring couplings

Inskruvningskoppling, Rak, typ GE

Art.nr:

GE 4 LL NPT 1/8 FZ	903996
GE 4 LL M8x1 FZ	3201012
GE 4 LL ISO-R1/8 FZ	903995
GE 6 L M14x1,5 FZ	904330
GE 6 L M16x1,5 FZ	903978
GE 6 L NPT 1/8 SF	3204017
GE 6 LL M10x1 FZ	3201110
GE 6 LL M6x1 FZ	3201173
GE 6 LL M8x1 FZ	906094
GE 6 LL ISO-G1/8 SF	3204014
GE 6 LL ISO-R1/8 FZ	903997
GE 6 L M10x1 FZ	904808
GE 6 L ISO-G1/4 FZ	906143
GE 6 L ISO-G1/4 SF	903013
GE 6 L ISO-G1/8 FZ	900016
GE 6 L ISO-G1/8 SF	3204200
GE 6 S ISO-G1/4 FZ	903998
GE 6 S ISO-G1/4 SF	3204015
GE 6 S ISO-G1/8 FZ	3204018
GE 8 LL M10x1 FZ	904814
GE 8 LL ISO-G1/4 FZ	904002
GE 8 LL ISO-G1/8 FZ	904003
GE 8 LL ISO-G1/8 SF	903001
GE 8 L ISO-R1/4 FZ	3201017
GE 8 L ISO-G1/4 SF	902994
GE 8 L ISO-G1/4 FZ	904004
GE 8 L ISO-G3/8 SF	904728
GE 8 L ISO-G3/8 FZ	904005
GE 8 L ISO-R1/2 FZ	3201021
GE 8 S M14x1,5 FZ	904807
GE 8 S ISO-G1/4 SF	3204300
GE 8 S ISO-G1/4 FZ	904001
GE 10 L M10x1 FZ	904332
GE 10 L M14x1,5 FZ	904813
GE 10 LL ISO-R1/4 FZ	904831
GE 10 L ISO-G1/2 FZ	903983
GE 10 L ISO-R1/4 FZ	3201018
GE 10 L ISO-G1/4 SF	903981
GE 10 L ISO-G1/4 FZ	904007
GE 10 L ISO-G3/8 SF	3204011
GE 10 L ISO-G3/8 FZ	904006
GE 10 S M14x1,5 FZ	904008
GE 10 S ISO-G1/4 SF	906661
GE 12 L ISO-R1/2 SS	906081
GE 12 LL ISO-G1/4 FZ	904010
GE 12 L M14x1,5 FZ	904331
GE 12 L ISO-G1/2 FZ	903999
GE 12 L ISO-G1/2 SF	3204025
GE 12 L ISO-G1/4 FZ	3201019
GE 12 L ISO-G1/4 SF	3204019
GE 12 L ISO-G1/8 SF	3204021
GE 12 L ISO-G3/8 SF	3204020
GE 12 L ISO-G3/8 FZ	904009
GE 12 S ISO-G1/4 SF	3204022
GE 12 S ISO-G3/8 FZ	3201242
GE 12 S ISO-G1/4 FZ	906337

Straight coupling type GE

Art.No:

GE 4 LL NPT 1/8 Zn	903996
GE 4 LL M8x1 Zn	3201012
GE 4 LL ISO-R1/8 Zn	903995
GE 6 L M14x1,5 Zn	904330
GE 6 L M16x1,5 Zn	903978
GE 6 L NPT 1/8 AISI 316	3204017
GE 6 LL M10x1 Zn	3201110
GE 6 LL M6x1 Zn	3201173
GE 6 LL M8x1 Zn	906094
GE 6 LL ISO-G1/8 AISI 316	3204014
GE 6 LL ISO-R1/8 Zn	903997
GE 6 L M10x1 Zn	904808
GE 6 L ISO-G1/4 Zn	906143
GE 6 L ISO-G1/4 AISI 316	903013
GE 6 L ISO-G1/8 Zn	900016
GE 6 L ISO-G1/8 AISI 316	3204200
GE 6 S ISO-G1/4 Zn	903998
GE 6 S ISO-G1/4 AISI 316	3204015
GE 6 S ISO-G1/8 AISI 316	3204018
GE 8 LL M10x1 Zn	904814
GE 8 LL ISO-G1/4 Zn	904002
GE 8 LL ISO-G1/8 Zn	904003
GE 8 LL ISO-G1/8 AISI 316	903001
GE 8 L ISO-R1/4 Zn	3201017
GE 8 L ISO-G1/4 AISI 316	902994
GE 8 L ISO-G1/4 Zn	904004
GE 8 L ISO-G 3/8 AISI 316	904728
GE 8 L ISO-G3/8 Zn	904005
GE 8 L ISO-R1/2 Zn	3201021
GE 8 S M14x1,5 Zn	904807
GE 8 S ISO-G1/4 AISI 316	3204300
GE 8 S ISO-G1/4 Zn	904001
GE 10 L M10x1 Zn	904332
GE 10 L M14x1,5 Zn	904813
GE 10 LL ISO-R1/4 Zn	904831
GE 10 L ISO-G1/2 Zn	903983
GE 10 L ISO-R1/4 Zn	3201018
GE 10 L ISO-G1/4 AISI 316	903981
GE 10 L ISO-G1/4 Zn	904007
GE 10 L ISO-G3/8 AISI 316	3204011
GE 10 L ISO-G3/8 Zn	904006
GE 10 S M14x1,5 Zn	904008
GE 10 S ISO-G1/4 AISI 316	906661
GE 12 L ISO-R1/2 AISI 316	906081
GE 12 LL ISO-G1/4 Zn	904010
GE 12 L M14x1,5 Zn	904331
GE 12 L ISO-G1/2 Zn	903999
GE 12 L ISO-G1/2 AISI 316	3204025
GE 12 L ISO-G1/4 Zn	3201019
GE 12 L ISO-G1/4 AISI 316	3204019
GE 12 L ISO-G1/8 AISI 316	3204021
GE 12 L ISO-G3/8 AISI 316	3204020
GE 12 L ISO-G3/8 Zn	904009
GE 12 S ISO-G1/4 AISI 316	3204022
GE 12 S ISO-G3/8 Zn	3201242
GE 12 S ISO-G1/4 Zn	906337

GE 15 L ISO-G1/2 SF	3204013	<i>GE 15 L ISO-G1/2 AISI 316</i>	3204013
GE 15 L ISO-G1/2 FZ	904012	<i>GE 15 L ISO-G1/2 Zn</i>	904012
GE 15 ISO-G1/2 MSG	906309	<i>GE 15 ISO-G1/2 Brass</i>	906309
GE 16 S ISO-G1/2 FZ	3201135	<i>GE 16 S ISO-G1/2 Zn</i>	3201135
GE 18 L ISO-G1/2 SF	3204301	<i>GE 18 L ISO-G1/2 AISI 316</i>	3204301
GE 18 L ISO-G1/2 FZ	3201153	<i>GE 18 L ISO-G1/2 Zn</i>	3201153
GE 20 S ISO-G1 FZ	3201132	<i>GE 20 S ISO-G1 Zn</i>	3201132
GE 22 L ISO-G1/2 FZ	3201172	<i>GE 22 L ISO-G1/2 Zn</i>	3201172
GE 22 L ISO-G1/2 SF	906430	<i>GE 22 L ISO-G1/2 AISI 316</i>	906430
GE 22 L ISO-G1FZ	3201130	<i>GE 22 L ISO-G1 Zn</i>	3201130
GE 22 L ISO-G1 SF	906593	<i>GE 22 L ISO-G1 AISI 316</i>	906593
GE 22 L ISO-G3/4 FZ	3201115	<i>GE 22 L ISO-G3/4 Zn</i>	3201115
GE 22 L ISO-G3/4 SF	3204023	<i>GE 22 L ISO-G3/4 AISI 316</i>	3204023
GE 25 S ISO-G3/4 SF	3204012	<i>GE 25 S ISO-G3/4 AISI 316</i>	3204012
GE 25 S ISO-G3/4 FZ	3201129	<i>GE 25 S ISO-G3/4 Zn</i>	3201129
GE 25 S ISO-G1FZ	3201131	<i>GE 25 S ISO-G1 Zn</i>	3201131
GE 25 S ISO-G1/2 SF	906659	<i>GE 25 S ISO-G1/2 AISI 316</i>	906659
GE 28 L ISO-G1 SF	3204016	<i>GE 28 L ISO-G1 AISI 316</i>	3204016
GE 28 L ISO-G1 FZ	3201134	<i>GE 28 L ISO-G1 Zn</i>	3201134
GE 28 L ISO-G3/4 FZ	3201159	<i>GE 28 L ISO-G3/4 Zn</i>	3201159
GE 30 S ISO-G1 FZ	906574	<i>GE 30 S ISO-G1 Zn</i>	906574
GE 30 S ISO-G3/4 FZ	903056	<i>GE 30 S ISO-G3/4 Zn</i>	903056
GE 35 L ISO-G1 FZ	907062	<i>GE 35 L ISO-G1 Zn</i>	907062



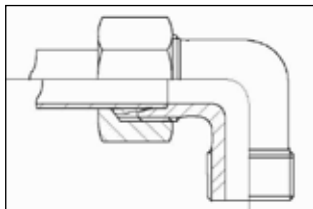

90° Vinkelinskruvnings- koppling Typ WE	Art.nr:	90° elbow connection type WE	Art.No:
WE 4 LL NPT 1/8 FZ	904060	WE 4 LL NPT1/8 Zn	904060
WE 4 LL M6x1 FZ	906022	WE 4 LL M6x1 Zn	906022
WE 4 LL M8x1 FZ	3201023	WE 4 LL M8x1 Zn	3201023
WE 4 LL ISO-G1/8 FZ	904061	WE 4 LL ISO-G1/8 Zn	904061
WE 6 LL ISO-G1/8 FZ	904062	WE 6 LL ISO-G1/8 Zn	904062
WE 6 LL M10x1 FZ	906095	WE 6 LL M10x1 Zn	906095
WE 6 LL M6x1 FZ	3201174	WE 6 LL M6x1 Zn	3201174
WE 6 LL M8x1 FZ	903009	WE 6 LL M8x1 Zn	903009
WE 6 LL ISO-G1/8 SF	3204024	WE 6 LL ISO-G1/8 AISI 316	3204024
WE 6 L M10x1 FZ	3201025	WE 6 LM ISO-G10x1 Zn	3201025
WE 6 L ISO-G1/8 FZ	3201139	WE 6 L ISO-G1/8 Zn	3201139
WE 6 L ISO-G1/8 SF	3204090	WE 6 L ISO-G1/8 AISI 316	3204090
WE 6 S ISO-G1/4 SF	3204089	WE 6 S ISO-G1/4 AISI 316	3204089
WE 6 S ISO-G1/4 FZ	904065	WE 6 S ISO-G1/4 Zn	904065
WE 8 LL ISO-G1/8 SF	3204121	WE 8 LL ISO-G1/8 AISI 316	3204121
WE 8 LL ISO-G1/8 FZ	904064	WE 8 LL ISO-G1/8 Zn	904064
WE 8 L ISO-G1/4 FZ	904063	WE 8 L ISO-G1/4 Zn	904063
WE 10 L ISO-G1/4 FZ	904069	WE 10 L ISO-G1/4 Zn	904069
WE 10 L ISO-G1/4 SF	906662	WE 10 L ISO-G1/4 AISI 316	906662
WE 12 L ISO-G1/2 SF	3204120	WE 12 L ISO-G1/2 AISI 316	3204120
WE 12 L ISO-G1/4 SF	3204119	WE 12 L ISO-G1/4 AISI 316	3204119
WE 12 LL ISO-G1/4 FZ	3201137	WE 12 LL ISO-G1/4 Zn	3201137
WE 12 L ISO-G1/2 FZ	3201143	WE 12 L ISO-G1/2 Zn	3201143
WE 12 L ISO-G1/4 FZ	3201027	WE 12 L ISO-G1/4 Zn	3201027
WE 12 L ISO-G3/8 FZ	904071	WE 12 L ISO-G3/8 Zn	904071
WE 12 L ISO-G3/8 SF	3204116	WE 12 L ISO-G3/8 AISI 316	3204116
WE 15 L ISO-G1/2 SF	3204118	WE 15 L ISO-G1/2 AISI 316	3204118
WE 15 L ISO-G1/2 FZ	3201230	WE 15 L ISO-G1/2 Zn	3201230
WE 16 S ISO-G3/8 FZ	3201136	WE 16 S ISO-G3/8 Zn	3201136
WE 18 L ISO-G1/2 SF	3204123	WE 18 L ISO-G1/2 AISI 316	3204123
WE 18 L ISO-G3/8 FZ	3201231	WE 18 L ISO-G3/8 Zn	3201231
WE 22 L ISO-G3/4 SF	3204117	WE 22 L ISO-G3/4 AISI 316	3204117
WE 22 L ISO-G3/4 FZ	3201233	WE 22 L ISO-G3/4 Zn	3201233
WE 28 L ISO-G1 SF	3204122	WE 28 L ISO-G1 AISI 316	3204122
WE 28 L ISO-G3/4 FZ	3201197	WE 28 L ISO-G3/4 Zn	3201197



Rak skarvkoppling, typ G	Art.nr:	Straight joint, type G	Art.No:
G 4 LL FZ	3201031	G 4 LL Zn	3201031
G 6 L FZ	3201235	G 6 L Zn	3201235
G 6 L SF	3204201	G 6 L AISI 316	3204201
G 6 LL FZ	903984	G 6 LL Zn	903984
G 6 LL SF	3204032	G 6 LL AISI 316	3204032
G 6 MSG	903985	G 6 Brass	903985
G 6 S SF	3204038	G 6 S AISI 316	3204038
G 8 L FZ	903986	G 8 L Zn	903986
G 8 L SF	3204026	G 8 L AISI 316	3204026
G 6 LL FZ	903987	G 6 LL Zn	903987
G 8 MSG	903988	G 8 Brass	903988
G 8 S SF	3204040	G 8 S AISI 316	3204040
G 10 L FZ	903989	G 10 L Zn	903989
G 10 L SF	3204028	G 10 L AISI 316	3204028
G 10 LL FZ	903990	G 10 LL Zn	903990
G 10 MSG	903991	G 10 Brass	903991
G 10 S SF	906660	G 10 S AISI 316	906660
G 12 L FZ	903992	G 12 L Zn	903992
G 12 L SF	3204034	G 12 L AISI 316	3204034
G 12 LL FZ	903993	G 12 LL Zn	903993
G 12 S FZ	3201118	G 12 S Zn	3201118
G 12 S SF	3204036	G 12 S AISI 316	3204036
G 12/10 L FZ	3201151	G 12/10 L Zn	3201151
G 15 L FZ	903994	G 15 L Zn	903994
G 15 L SF	3204035	G 15 L AISI 316	3204035
G 16 S FZ	3201035	G 16 S Zn	3201035
G 16 S SF	3204197	G 16 S AISI 316	3204197
G 18 L FZ	3201122	G 18 L Zn	3201122
G 18 L SF	3204029	G 18 L AISI 316	3204029
G 18/10 L FZ	3201149	G 18/10 L Zn	3201149
G 20 S FZ	3201038	G 20 S Zn	3201038
G 20 S SF	3204041	G 20 S AISI 316	3204041
G 22 L FZ	3201037	G 22 L Zn	3201037
G 22 L SF	3204037	G 22 L AISI 316	3204037
G 25 S FZ	3201155	G 25 S Zn	3201155
G 25 S SF	3204030	G 25 S AISI 316	3204030
G 28 L FZ	3201039	G 28 L Zn	3201039
G 28 L SF	3204039	G 28 L AISI 316	3204039
G 30 S FZ	3201156	G 30 S Zn	3201156
G 30 S SF	3204031	G 30 S AISI 316	3204031
G 35 L SF	3204033	G 35 L AISI 316	3204033
G 35 L FZ	907061	G 35 L Zn	907061

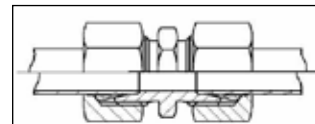

Montagematerial

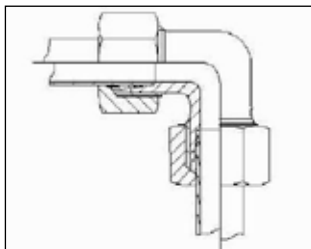

Vinkelskarvkoppling Typ W	Art.nr:	Elbow connector, Type W	Art.No:
W 4 LL FZ	904051	W 4 LL Zn	904051
W 6 LL FZ	904053	W 6 LL Zn	904053
W 6 MSG	904052	W 6 Brass	904052
W 8 L FZ	904057	W 8 L Zn	904057
W 8 L SF	903004	W 8 L AISI 316	903004
W 8 LL FZ	904054	W 8 LL Zn	904054
W 8 MSG	904056	W 8 Brass	904056
W 8 S SF	3204400	W 8 S AISI 316	3204400
W 12 L FZ	904058	W 12 L Zn	904058
W 12 L SF	3204402	W 12 L AISI 316	3204402
W 15 L FZ	3201207	W 15 L Zn	3201207
W 15 L SF	3204111	W 15 L AISI 316	3204111
W 18 L FZ	3201208	W 18 L Zn	3201208
W 18 L SF	3204112	W 18 L AISI 316	3204112
W 20 S FZ	902971	W 20 S Zn	902971
W 22 L FZ	3201209	W 22 L Zn	3201209
W 25 S SF	906756	W 25 S AISI 316	906756
W 28 L FZ	3201220	W 28 L Zn	3201220
W 28 L SF	3204401	W 28 L AISI 316	3204401
W 30 S FZ	906431	W 30 S Zn	906431
W 35 L SF	906369	W 35 L AISI 316	906369



T-skarvkoppling Typ T	Art.nr:	T-connector, type T	Art.No:
T 4 LL FZ	3201001	<i>T 4 LL Zn</i>	3201001
T 6 L SF	3204002	<i>T 6 L AISI 316</i>	3204002
T 6 LL FZ	3201002	<i>T 6 LL Zn</i>	3201002
T 8 L FZ	904042	<i>T 8 L Zn</i>	904042
T 8 L SF	902997	<i>T 8 L AISI 316</i>	902997
T 10 L FZ	3201006	<i>T 10 L AISI 316</i>	3201006
T 10 L SF	3204001	<i>T 10 L AISI 316</i>	3204001
T 12 L FZ	3201004	<i>T 12 L Zn</i>	3201004
T 12 L SF	3204004	<i>T 12 L AISI 316</i>	3204004
T 12 S FZ	3201011	<i>T 12 S Zn</i>	3201011
T 12 S SF	3204007	<i>T 12 S AISI 316</i>	3204007
T 15 L FZ	3201007	<i>T 15 L Zn</i>	3201007
T 16 S SF	3204009	<i>T 16 S AISI 316</i>	3204009
T 18 L FZ	3201010	<i>T 18 L Zn</i>	3201010
T 20 S FZ	3201191	<i>T 20 S Zn</i>	3201191
T 20 S SF	3204006	<i>T 20 S AISI 316</i>	3204006
T 22 L FZ	3201005	<i>T 22 L Zn</i>	3201005
T 22 L SF	3204005	<i>T 22 L AISI 316</i>	3204005
T 25 S FZ	3201169	<i>T 25 S Zn</i>	3201169
T 25 S SF	3204000	<i>T 25 S AISI 316</i>	3204000
T 28 L FZ	3201008	<i>T 28 L Zn</i>	3201008
T 28 L SF	3204008	<i>T 28 L AISI 316</i>	3204008
T 30 S FZ	3201009	<i>T 30 S Zn</i>	3201009
T 30 S SF	3204198	<i>T 30 S AISI 316</i>	3204198
T 35 L SF	906368	<i>T 35 L AISI 316</i>	906368

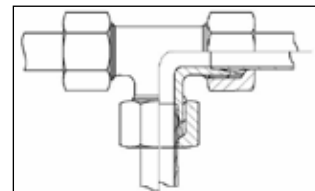

Montagematerial

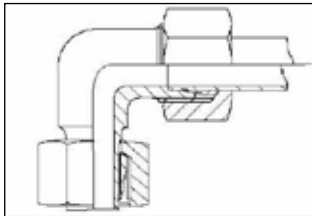

Ställbar vinkelkoppling Typ EVW

Art.nr:

**Adjustable elbow
connector, type EVW**

Part Number:

EVW 6 L FZ
EVW 6 S FZ

**900018
904832**

*EVW 6 L Zn
EVW 6 S Zn*

**900018
904832**

EVW 8 L FZ
EVW 8 L SF

**904076
903003**

*EVW 8 L Zn
EVW 8 L AISI 316*

**904076
903003**

EVW 10 L FZ

904077

EVW 10 L Zn

904077

EVW 12 L FZ
EVW 12 L SF

**904078
3204115**

*EVW 12 L Zn
EVW 12 L AISI 316*

**904078
3204115**

EVW 22 L SF

3204114

EVW 22 L AISI 316

3204114

EVW 28 L SF

3204113

EVW 28 L AISI 316

3204113

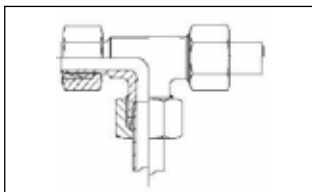

Ställbar L-koppling Typ EVL

Art.nr:

**Adjustable L-connector,
type EVL**

Part Number:

EVL 8 L FZ

902978

EVL 8 L Zn

902978

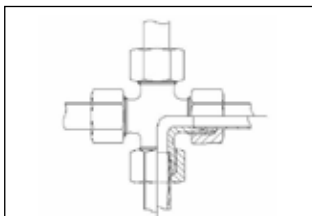

Korsskarvkoppling Typ K

Art.nr:

**Cross connector,
Type K**

Part Number:

K 8 L FZ
K 8 L SF

**904017
903000**

*K 8 L Zn
K 8 L AISI 316*

**904017
903000**

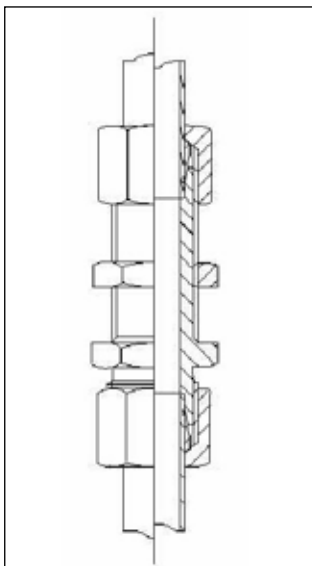

Rak skottgenomgång Typ SV

Art.nr:

**Straight bulkhead,
Type SV**

Part Number:

SV 4 LL FZ

3201048

SV 4 LL Zn

3201048

SV 6 L FZ
SV 6 L SF

**3201049
3204203**

*SV 6 L Zn
SV 6 L AISI 316*

**3201049
3204203**

SV 8 L FZ

3201050

SV 8 L Zn

3201050

SV 10 L SF

906413

SV 10 L AISI 316

906413

SV 12 L FZ
SV 12 L SF

**3201051
3204051**

*SV 12 L Zn
SV 12 L AISI 316*

**3201051
3204051**

SV 22 L FZ

3201240

SV 22 L Zn

3201240

SV 25 S FZ

3201241

SV 25 S Zn

3201241

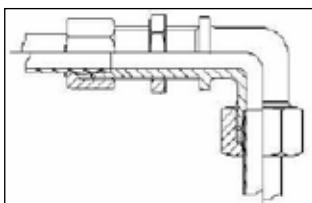

Vinkelskottgenomgång Typ WSV

Art.nr:

**Bulkhead elbow,
Type WSV**

Part Number:

WSV 6 L FZ
WSV 6 L SS

**904072
903057**

*WSV 6 L Zn
WSV 6 L AISI 316*

**904072
903057**

WSV 8 L FZ

904073

WSV 8 L Zn

904073

WSV 10 L FZ

904074

WSV 10 L Zn

904074

WSV 12 L FZ
WSV 12 L SF
WSV 12 L SF

**3201106
904075
906825**

*WSV 12 L Zn
WSV 12 L Zn
WSV 12 L AISI 316*

**3201106
904075
906825**



Manometerkoppling Typ MAV	Art.nr:	Manometer coupling, type MAV	Part Number:
MAV 4 LL ISO-G1/4 FZ	900649	MAV 4 LL Zn	900649
MAV 6 L ISO-G1/4 FZ	900650	MAV 6 LR Zn	900650
MAV 8 L ISO-G1/4 FZ	900651	MAV 8 L ISO-G1/4 Zn	900651
MAV 8 S ISO-G1/2 FZ	904024	MAV 8 S ISO-G1/2 Zn	904024
MAV 12 L ISO-G1/4 FZ	900653	MAV 12 L ISO-G1/4 Zn	900653

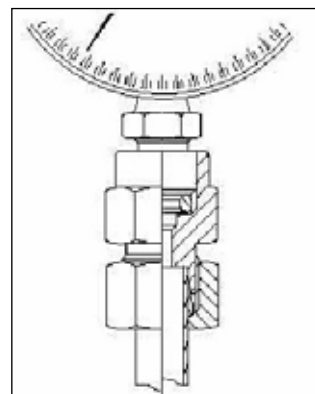

Manometerkoppling förmonterad mutter och skärring Typ MAV-EV	Art.nr:	Manometer coupling, pre-assembled nut and cut ring type MAV-EV	Part Number:
MAV-EV 12 S ISO-G1/2 FZ	902970	MAV-EV 12 S ISO-G1/2 Zn	902970

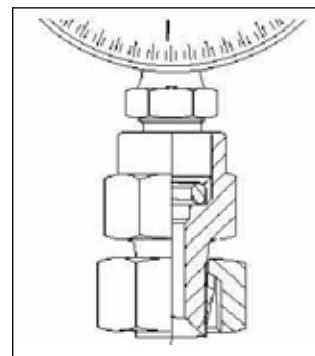

Rak koppling med invändig gänga Typ GAI	Art.nr:	Straight connector, female, type GAI	Part Number:
GAI 6 L ISO-G1/8 SF	903018	GAI 6 L ISO-G1/8 AISI 316	903018
GAI 8 L ISO-G1/4 FZ	904013	GAI 8 L ISO-G1/4 Zn	904013
GAI 15 L ISO-G1/2 FZ	904014	GAI 15 L ISO-G1/2 Zn	904014
GAI 22 L ISO-G3/4 FZ	906595	GAI 22 L ISO-G3/4 Zn	906595

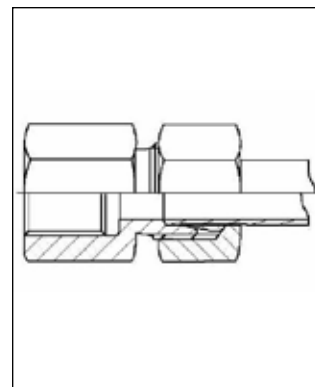

Rak inskruvningsstuds Typ EVGE	Art.nr:	Straight connector, type EVGE	Part Number:
EVGE 8 L ISO-G1/4 SF	905996	EVGE 8 L ISO-G1/4 AISI 316	905996
EVGE 8 S ISO-G1/4 FZ	903982	EVGE 8 S ISO-G1/4 Zn	903982
EVGE 10 L ISO-G1/4 SF	903055	EVGE 10 L ISO-G1/4 AISI 316	903055
EVGE 12 L ISO-G1/2 FZ	906305	EVGE 12 L ISO-G1/2 Zn	906305
EVGE 12 S ISO-G1/2 FZ	902973	EVGE 12 S ISO-G1/2 Zn	902973

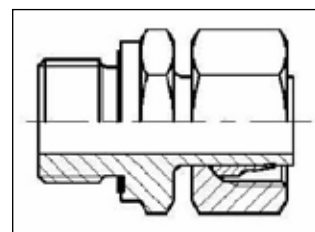

Rörstuds, SF	Art.nr:	Stud, Acid-proof	Part Number:
8 L 1/4"	903002	8 L 1/4"	903002
12 L 1/4"	3204210	12 L 1/4"	3204210
15 L 1/2"	3204221	15 L 1/2"	3204221
18 L 1/2"	3204209	18 L 1/2"	3204209
20 S 3/4"	3204222	20 S 3/4"	3204222
Rörstuds, FZ	Art.nr:	Stud, zinc-plated	Part Number:
8 L 1/4"	906004	8 L 1/4"	906004

Montagematerial

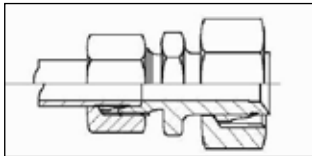

Konreducering Typ KOR	Art.nr:	Cone reducing, Type KOR	Part Number:
KOR 6/4 LL FZ	904021	KOR 6/4 LL Zn	904021
KOR 8/4 LL FZ	904727	KOR 8/4 LL Zn	904727
KOR 8/6 L FZ	3201041	KOR 8/6 L Zn	3201041
KOR 8/6 L SF	3204107	KOR 8/6 L AISI 316	3204107
KOR 10/6 L FZ	3201040	KOR 10/6 L Zn	3201040
KOR 10/8 L FZ	904102	KOR 10/8 L Zn	904102
KOR 12/6 L FZ	3201042	KOR 12/6 L Zn	3201042
KOR 12/6 L SF	3204042	KOR 12/6 L AISI 316	3204042
KOR 12/8 L FZ	906478	KOR 12/8 L Zn	906478
KOR 12/8 L SF	903021	KOR 12/8 L AISI 316	903021
KOR 12/10 FZ	3201045	KOR 12/10 Zn	3201045
KOR 12/10 L SF	3204108	KOR 12/10 L AISI 316	3204108
KOR 15/12 L FZ	3201047	KOR 15/12 L Zn	3201047
KOR 15/12 L SF	906594	KOR 15/12 L AISI 316	906594
KOR 20/12 S FZ	3201108	KOR 20/12 S Zn	3201108
KOR 22/12 L FZ	3201043	KOR 22/12 L Zn	3201043
KOR 22/12 L SF	3204043	KOR 22/12 L AISI 316	3204043
KOR 22/15 L	3201096	KOR 22/15 L	3201096
KOR 22/15 L SF	3204110	KOR 22/15 L AISI 316	3204110
KOR 25/12 S FZ	3201165	KOR 25/12 S Zn	3201165
KOR 25/12 S SF	3204092	KOR 25/12 S AISI 316	3204092
KOR 25/20 S SF	3204094	KOR 25/20 S AISI 316	3204094
KOR 28/12 L FZ	3201095	KOR 28/12 L Zn	3201095
KOR 28/12 L SF	3204093	KOR 28/12 L AISI 316	3204093
KOR 28/18 L SF	3204109	KOR 28/18 L AISI 316	3204109
KOR 28/22 L FZ	3201046	KOR 28/22 L Zn	3201046
KOR 28/22 L SF	3204027	KOR 28/22 L AISI 316	3204027
KOR 30/12 S FZ	3201044	KOR 30/12 S Zn	3201044
KOR 30/25 FZ	906249	KOR 30/25 Zn	906249



Skärring Typ DPR	Art.nr:	Cut ring, type DPR	Part Number:
DPR 4 LL FZ	3201065	<i>DPR 4 LL Zn</i>	3201065
DPR 6 L/S SF	3204066	<i>DPR 6 L/S AISI 316</i>	3204066
DPR 6 L/S FZ	900594	<i>DPR 6 L/S Zn</i>	900594
DPR 6 LL FZ	3201067	<i>DPR 6 LL Zn</i>	3201067
DPR 6 LL SF	3204067	<i>DPR 6 LL AISI 316</i>	3204067
DPR 8 L/S SF	902998	<i>DPR 8 L/S AISI 316</i>	902998
DPR 8 L/S FZ	900595	<i>DPR 8 L/S Zn</i>	900595
DPR 8 LL FZ	3201069	<i>DPR 8 LL Zn</i>	3201069
DPR 10 L/S FZ	3201072	<i>DPR 10 L/S Zn</i>	3201072
DPR 10 L/S SF	3204064	<i>DPR 10 L/S AISI 316</i>	3204064
DPR 10 LL	D10-LL	<i>DPR 10 LL Zn</i>	D10-LL
DPR 12 L/S SF	3204070	<i>DPR 12 L/S AISI 316</i>	3204070
DPR 12 L/S FZ	3201070	<i>DPR 12 L/S Zn</i>	3201070
DPR 15 L FZ	3201074	<i>DPR 15 L Zn</i>	3201074
DPR 15 L SF	3204072	<i>DPR 15 L AISI 316</i>	3204072
DPR 18 L FZ	3201160	<i>DPR 18 L Zn</i>	3201160
DPR 18 L SF	3204069	<i>DPR 18 L AISI 316</i>	3204069
DPR 20 S FZ	3201167	<i>DPR 20 S Zn</i>	3201167
DPR 20 S SF	906663	<i>DPR 20 S AISI 316</i>	906663
DPR 22 L FZ	3201071	<i>DPR 22 L Zn</i>	3201071
DPR 22 L SF	3204071	<i>DPR 22 L AISI 316</i>	3204071
DPR 25 S FZ	3201168	<i>DPR 25 S Zn</i>	3201168
DPR 25 S SF	3204065	<i>DPR 25 S AISI 316</i>	3204065
DPR 28 L FZ	3201073	<i>DPR 28 L Zn</i>	3201073
DPR 28 L SF	3204073	<i>DPR 28 L AISI 316</i>	3204073
DPR 30 S FZ	3201090	<i>DPR 30 S Zn</i>	3201090
DPR 30 S SF	906394	<i>DPR 30 S AISI 316</i>	906394

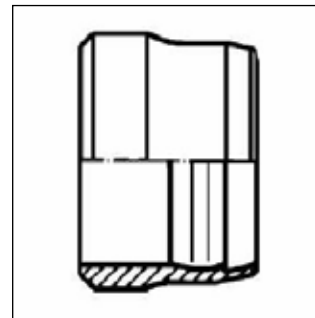

Montagematerial

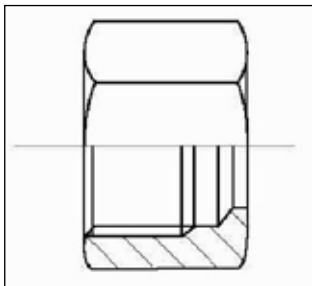

Mutter Typ M	Art.nr:	Nut, Type M	Part Number:
M 4 LL FZ	902773	<i>M 4 LL Zn</i>	902773
M 6 L FZ	3201166	<i>M 6 L Zn</i>	3201166
M 6 L SF	3204044	<i>M 6 L AISI 316</i>	3204044
M 6 LL FZ	3201060	<i>M 6 LL Zn</i>	3201060
M 6 LL SF	3204045	<i>M 6 LL AISI 316</i>	3204045
M 8 L FZ	3201061	<i>M 8 L Zn</i>	3201061
M 8 L SF	902999	<i>M 8 L AISI 316</i>	902999
M 10 L FZ	3201063	<i>M 10 L Zn</i>	3201063
M 12 L FZ	3201062	<i>M 12 L Zn</i>	3201062
M 12 L SF	3204046	<i>M 12 L AISI 316</i>	3204046
M 18 L FZ	3201064	<i>M 18 L Zn</i>	3201064
M 22 L FZ	3201170	<i>M 22 L Zn</i>	3201170
M 22 L SF	3204047	<i>M 22 L AISI 316</i>	3204047
M 28 L FZ	907349	<i>M 28 L FZ</i>	907349
M 28 L SF	907350	<i>M 28 L AISI 316</i>	907350
M 30 S FZ	907351	<i>M 30 S FZ</i>	907351



Rörklammer, FZ	Art.nr:	Tube clamp, Zn	Part Number:
6x1	3402046	6x1	3402046
6x2	3402047	6x2	3402047
6x3	3402048	6x3	3402048
6x4	3402049	6x4	3402049
6x5	3402050	6x5	3402050
6x6	3402051	6x6	3402051

Rörklammer, SF	Art.nr:	Tube clamp, AISI 316	Part Number:
6x1	3404046	6x1	3404046
6x2	3404047	6x2	3404047
6x3	3404048	6x3	3404048
6x4	3404049	6x4	3404049
6x5	3404050	6x5	3404050
6x6	3404051	6x6	3404051



Skena för rörhållare	Art.nr:	Mounting rail for below tube clamp	Part Number:
1x12	101601	1x12	101601
2x12	101602	2x12	101602
2x22	101603	2x22	101603
2x28	101604	2x28	101604
1x22	101605	1x22	101605
1x28	101606	1x28	101606



Rörhållare	Art.nr:	Tube clamp	Part Number:
För dia 12 mm	3413005	For diameter 12 mm	3413005
För dia 22 mm	3413002	For diameter 22 mm	3413002
För dia 28 mm	3413004	For diameter 28 mm	3413004



Rör

Tube



Art. Nr. Part Number	Dim	Material	Typ Type	Standard	kg/m
900169	6x1	E 235 (ST37.4) FZ / ZN	sömlöst / seamless	EN 10305-4 (DIN 2391/C)	0.12
900170	8x1	E 235 (ST37.4) FZ / ZN	sömlöst / seamless	EN 10305-4 (DIN 2391/C)	0.17
900171	10x1	E 235 (ST37.4) FZ / ZN	sömlöst / seamless	EN 10305-4 (DIN 2391/C)	0.22
900172	12x1	E 235 (ST37.4) FZ / ZN	sömlöst / seamless	EN 10305-4 (DIN 2391/C)	0.27
902912	12x1.5	E 235 (ST37.4) FZ / ZN	sömlöst / seamless	EN 10305-4 (DIN 2391/C)	0.39
900173	15x1.5	E 235 (ST37.4) FZ / ZN	sömlöst / seamless	EN 10305-4 (DIN 2391/C)	0.50
902596	18x1.5	E 235 (ST37.4) FZ / ZN	sömlöst / seamless	EN 10305-4 (DIN 2391/C)	0.61
3102007	22x2	E 235 (ST37.4) FZ / ZN	sömlöst / seamless	EN 10305-4 (DIN 2391/C)	0.99
906979	28x2	E 235 (ST37.4) FZ / ZN	sömlöst / seamless	EN 10305-4 (DIN 2391/C)	1.28
3102009	28x2.5	E 235 (ST37.4) FZ / ZN	sömlöst / seamless	EN 10305-4 (DIN 2391/C)	1.57
903022	30x4	E 235 (ST37.4) FZ / ZN	sömlöst / seamless	EN 10305-4 (DIN 2391/C)	2.57
902579	6x1	SS2348 / SS2350 / AISI 316	sömlöst / seamless	EN 10216-5 TC1 (DIN 17458 PK1)	0.12
907011	10x1	SS2348 / SS2350 / AISI 316	sömlöst / seamless	EN 10216-5 TC1 (DIN 17458 PK1)	0.22
907012	12x1	SS2348 / SS2350 / AISI 316	sömlöst / seamless	EN 10216-5 TC1 (DIN 17458 PK1)	0.27
903008	12x1.5	SS2348 / SS2350 / AISI 316	sömlöst / seamless	EN 10216-5 TC1 (DIN 17458 PK1)	0.39
907013	15x1.5	SS2348 / SS2350 / AISI 316	sömlöst / seamless	EN 10216-5 TC1 (DIN 17458 PK1)	0.50
907014	22x2	SS2348 / SS2350 / AISI 316	sömlöst / seamless	EN 10216-5 TC1 (DIN 17458 PK1)	0.99
907015	28x2	SS2348 / SS2350 / AISI 316	sömlöst / seamless	EN 10216-5 TC1 (DIN 17458 PK1)	1.28
907097	28x2.5	SS2348 / SS2350 / AISI 316	sömlöst / seamless	EN 10216-5 TC1 (DIN 17458 PK1)	1.57
3104001	6x1	SS2348 / SS2350 / AISI 316	svetsat/welded D4/T3	EN 10217-7 TC1 (DIN 17457 PK1)	0.12
903019	8x1	SS2348 / SS2350 / AISI 316	svetsat/welded D4/T3	EN 10217-7 TC1 (DIN 17457 PK1)	0.17
3104007	10x1	SS2348 / SS2350 / AISI 316	svetsat/welded D4/T3	EN 10217-7 TC1 (DIN 17457 PK1)	0.22
3104002	12x1	SS2348 / SS2350 / AISI 316	svetsat/welded D4/T3	EN 10217-7 TC1 (DIN 17457 PK1)	0.27
3104003	22x2	SS2348 / SS2350 / AISI 316	svetsat/welded D4/T3	EN 10217-7 TC1 (DIN 17457 PK1)	0.99
3104005	28x2	SS2348 / SS2350 / AISI 316	svetsat/welded D4/T3	EN 10217-7 TC1 (DIN 17457 PK1)	1.28
3104006	28x2.5	SS2348 / SS2350 / AISI 316	svetsat/welded D4/T3	EN 10217-7 TC1 (DIN 17457 PK1)	1.57
906248	30x4	SS2348 / SS2350 / AISI 316	svetsat/welded D4/T3	EN 10217-7 TC1 (DIN 17457 PK1)	2.57

